

Proposte di installazione Self pay kiosk_21
con banco modadori

Versione da banco



Versione con colonna



SELF PAY KIOSK_21

Versione da banco – misure principali

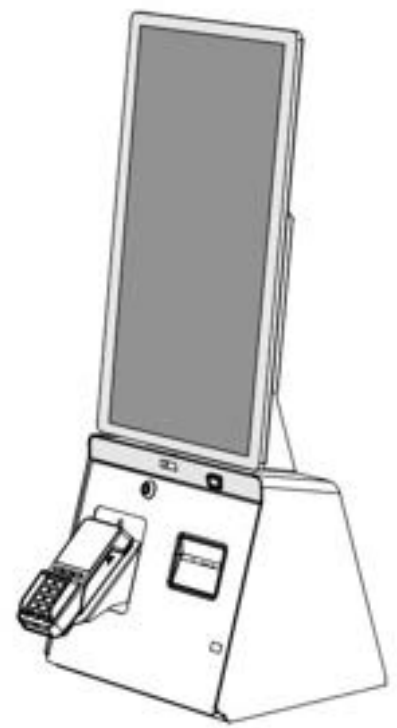
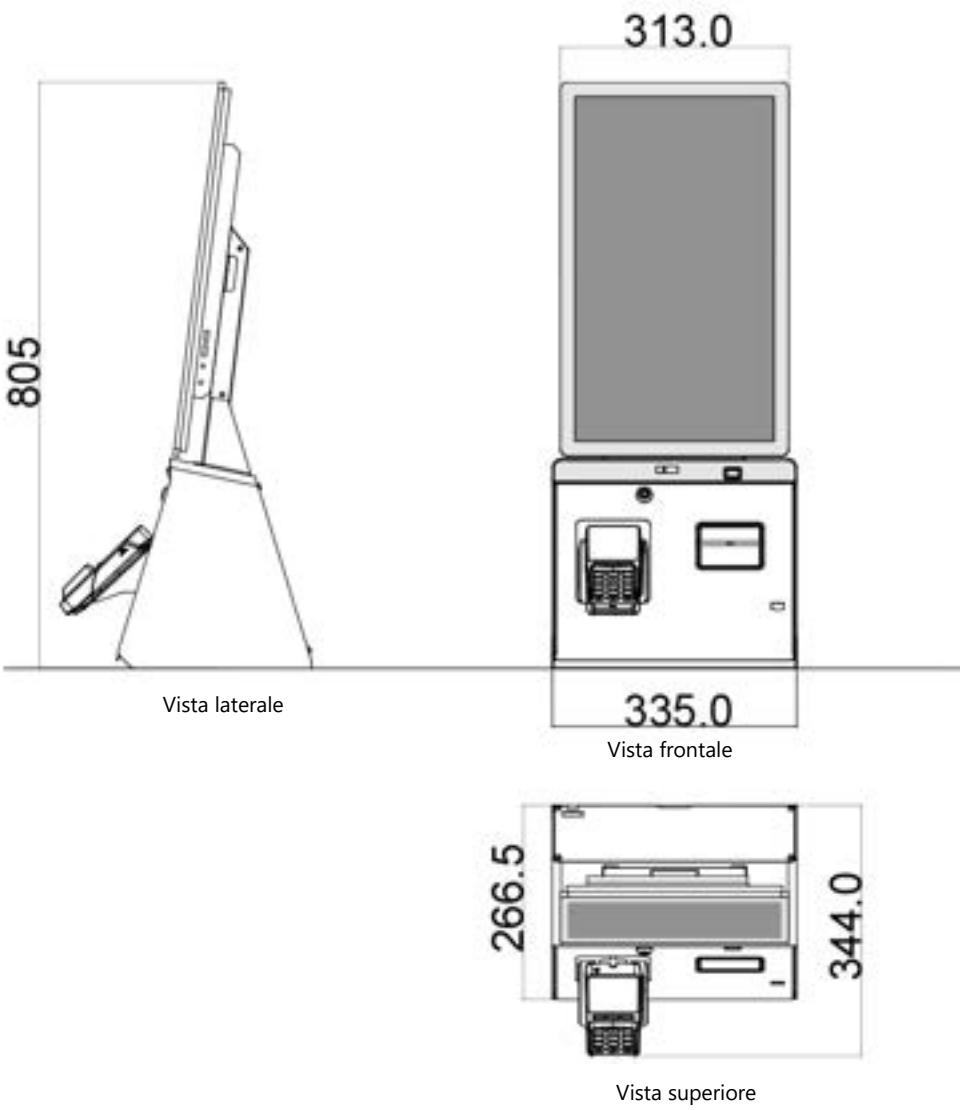

Misure espresse in «mm»

SELF PAY KIOSK_21

Versione con colonna – misure principali

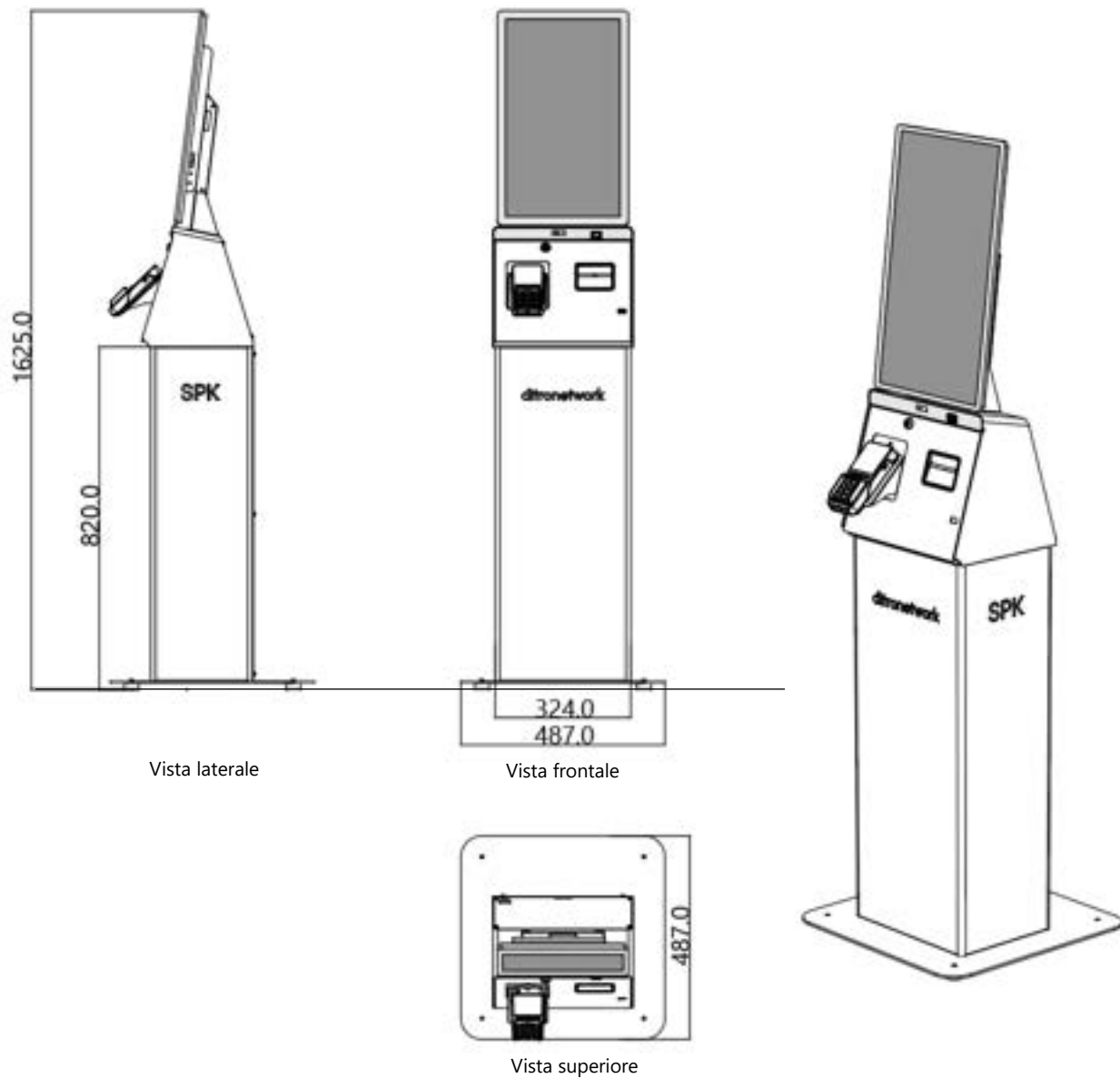

È possibile fissare l'assieme al pavimento, oppure inserire delle rotelle

PROPOSTE DI INSTALLAZIONE CON BANCO MONDADORI

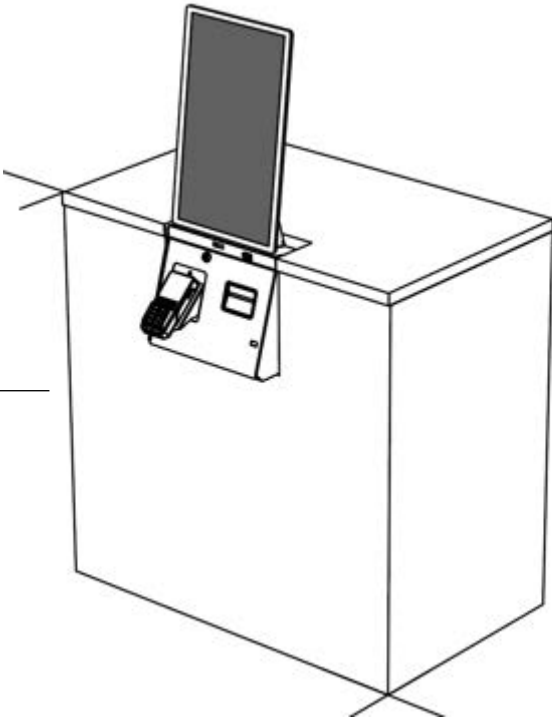

PROPOSTA (A)

Incasso parziale del SPK
sul frontale del banco

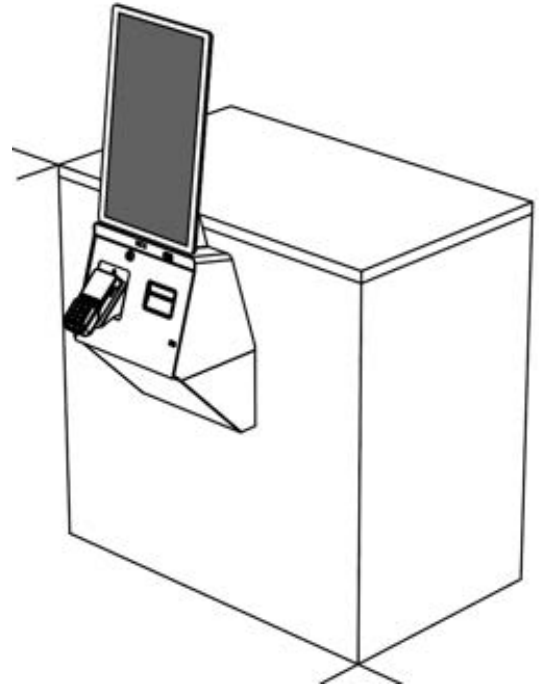

PROPOSTA (B)

Posizionamento
esterno del SPK su supporto
di metallo

Proposta **A**

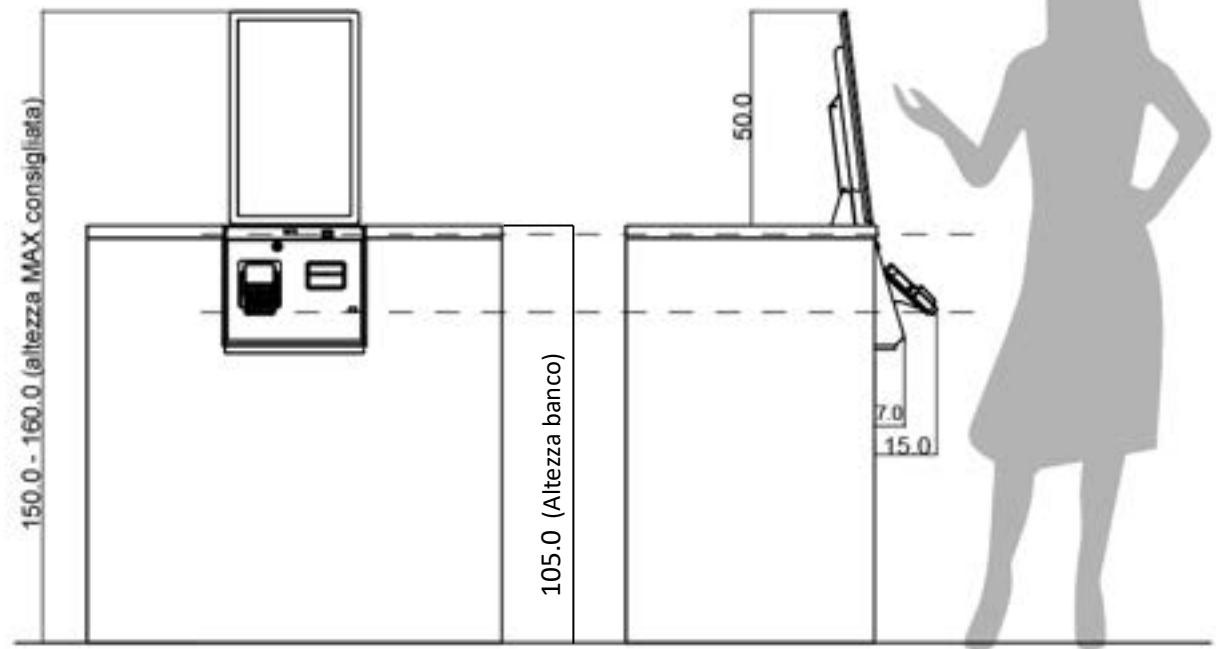

Vista frontale

Vista laterale

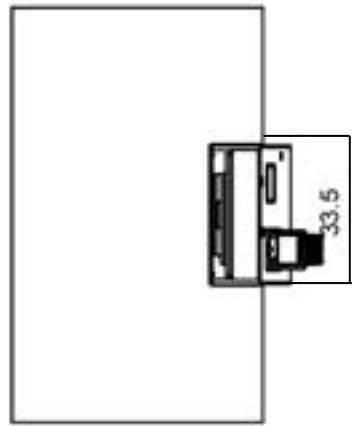

Vista superiore

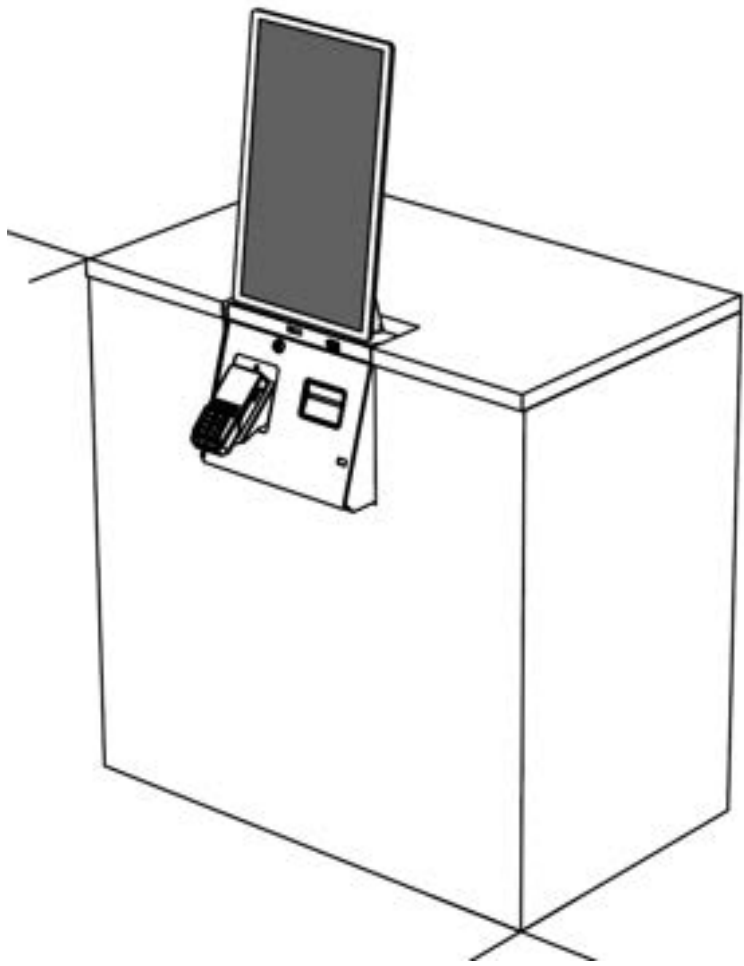

Proposta **A**

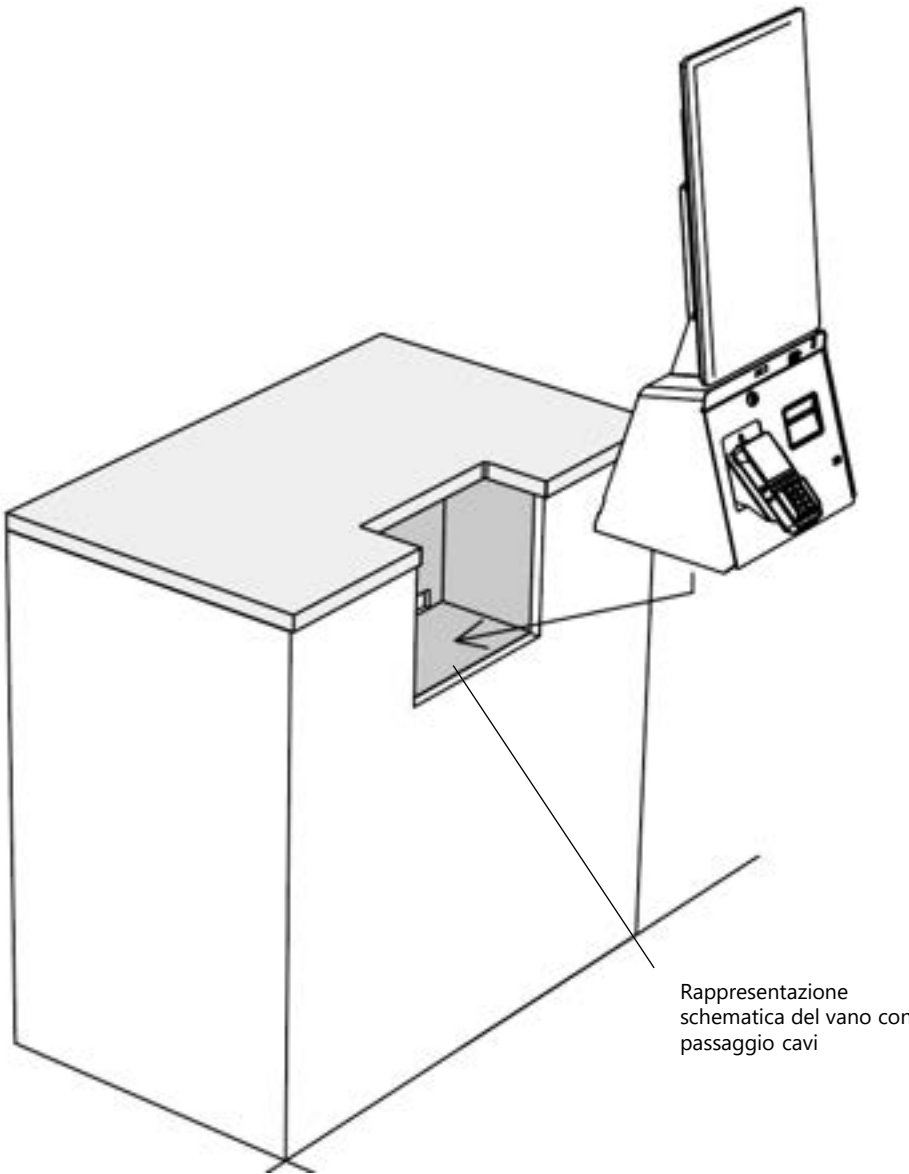

Rappresentazione schematica del vano con passaggio cavi

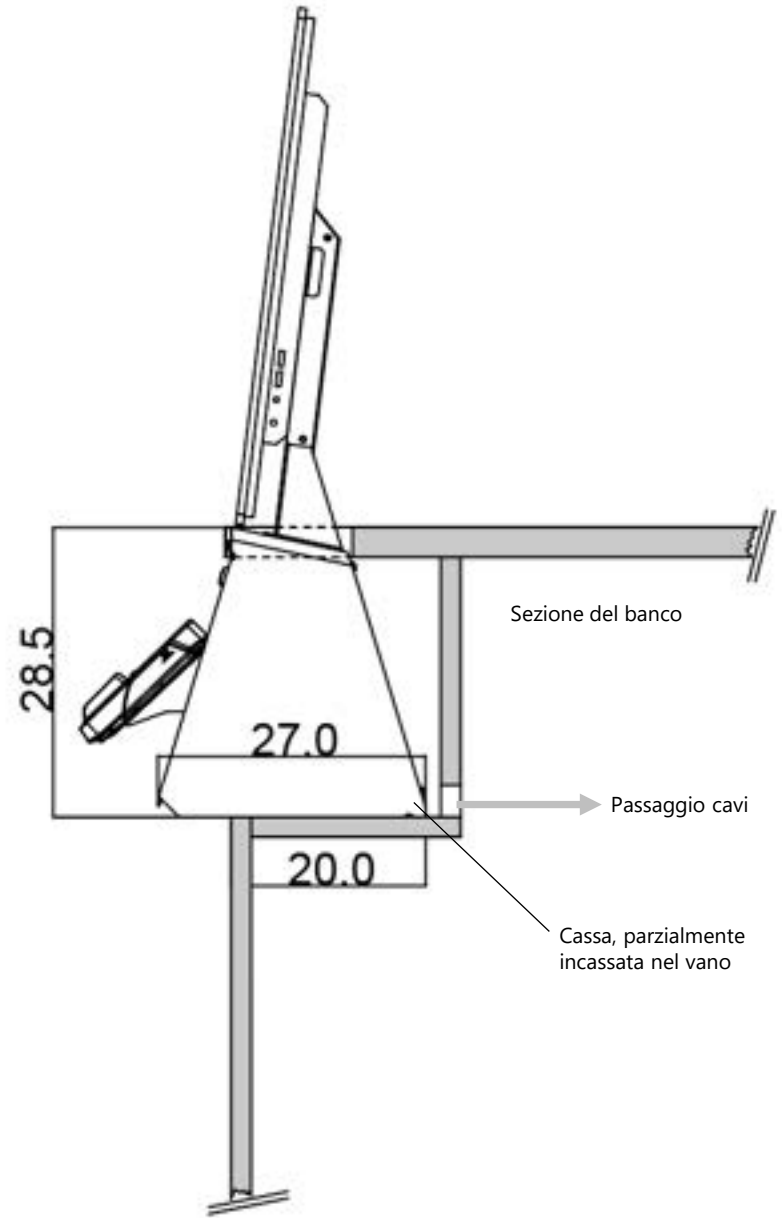

Proposta **A**



Esempio di installazione – misure espresse in cm (+ / -1cm)

Proposta **B**

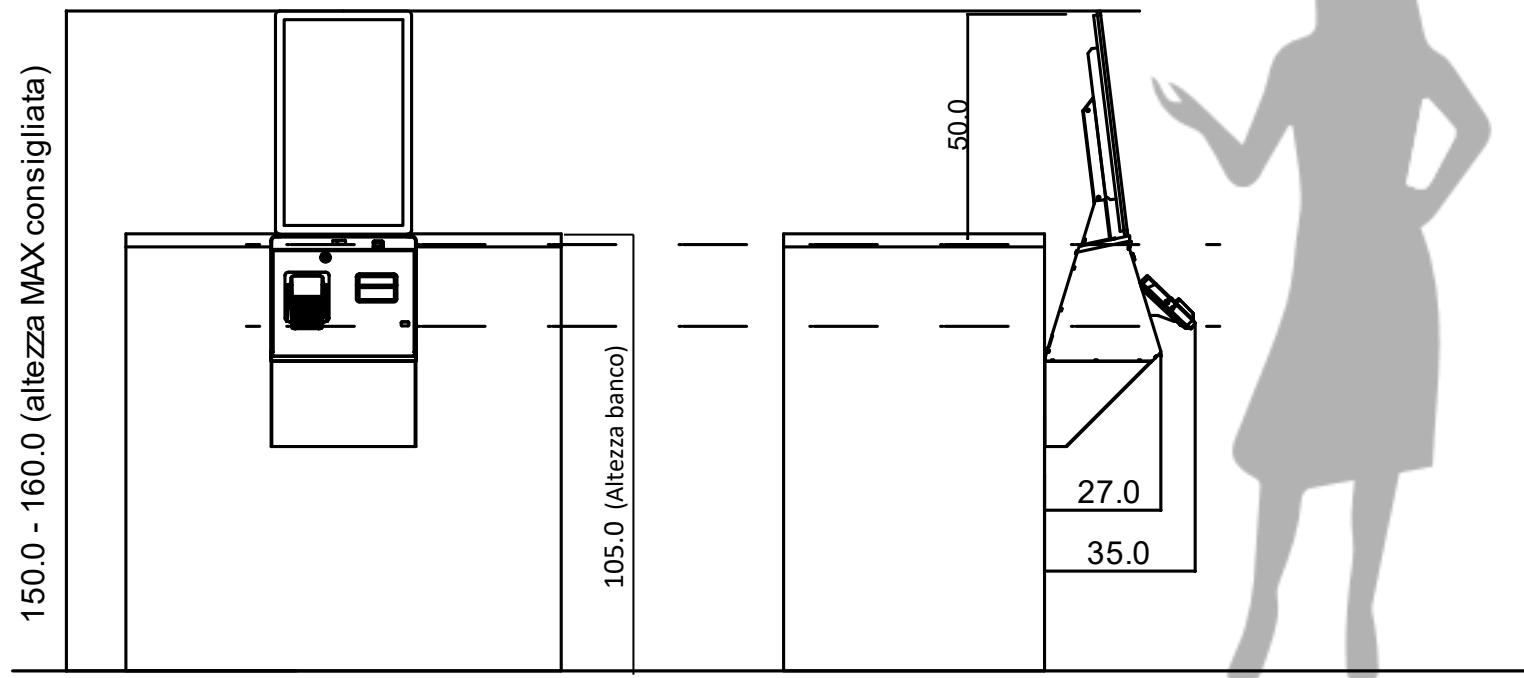

Vista frontale

Vista laterale

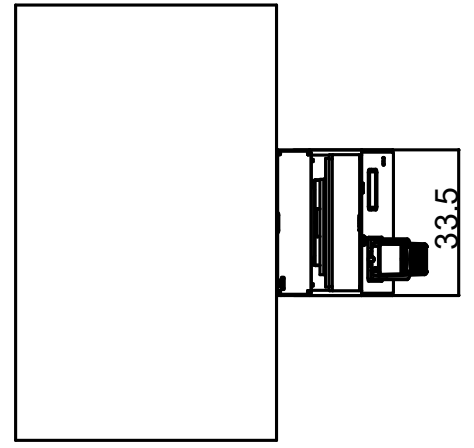

Vista superiore

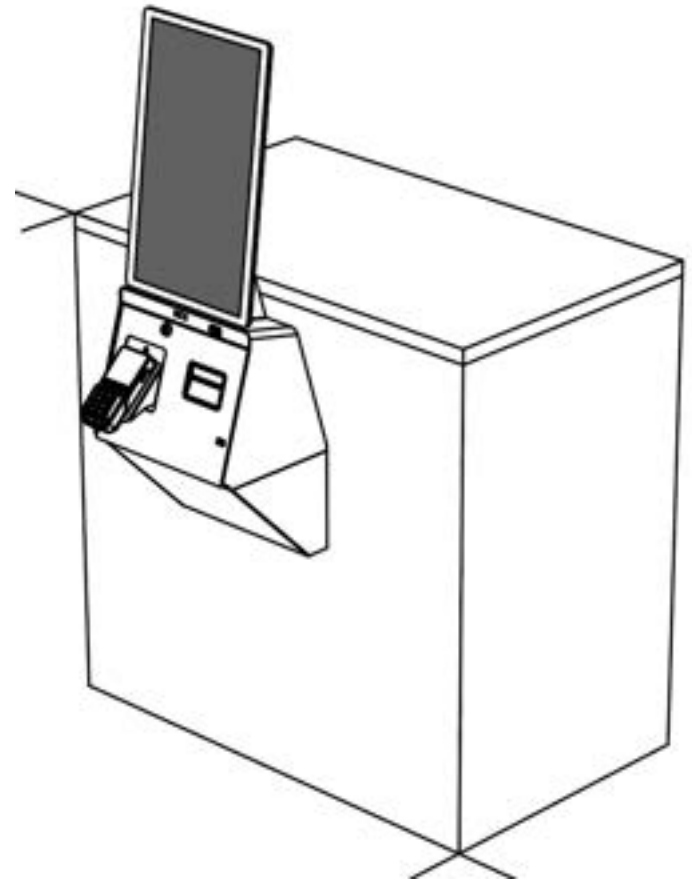

Proposta **B**

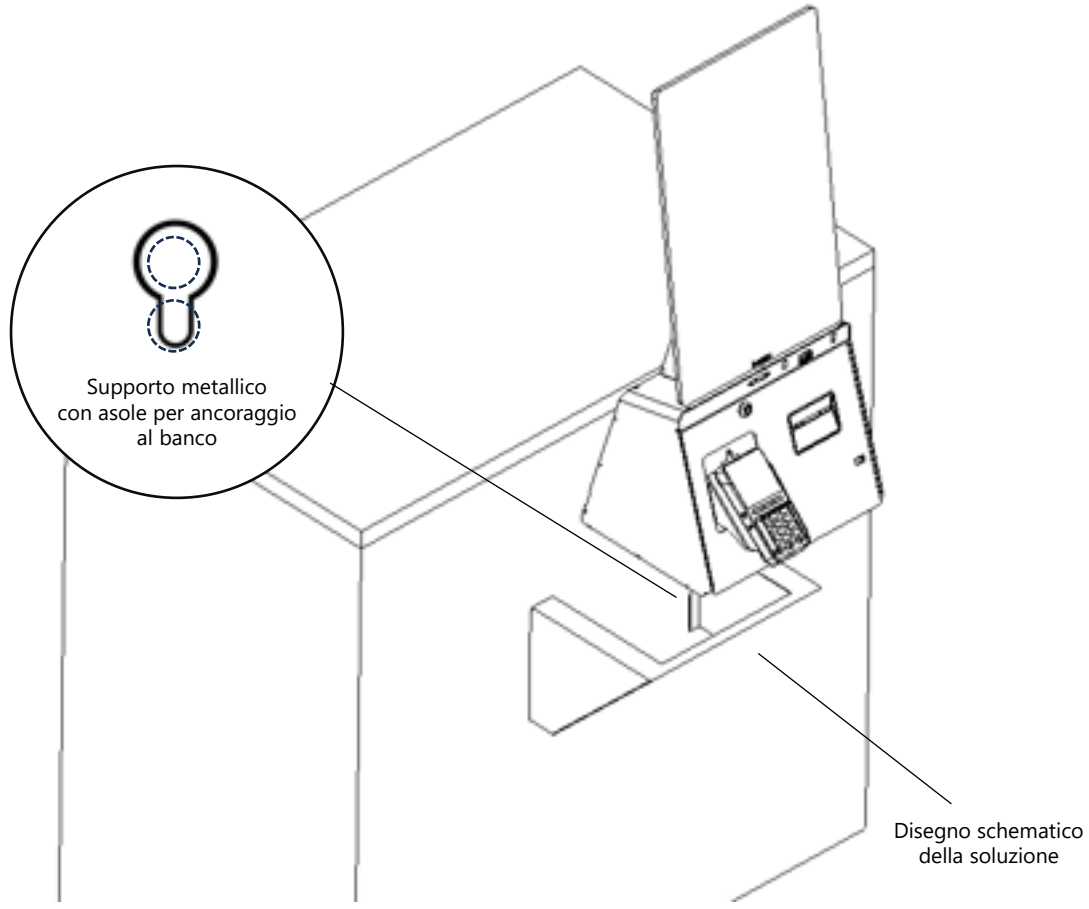
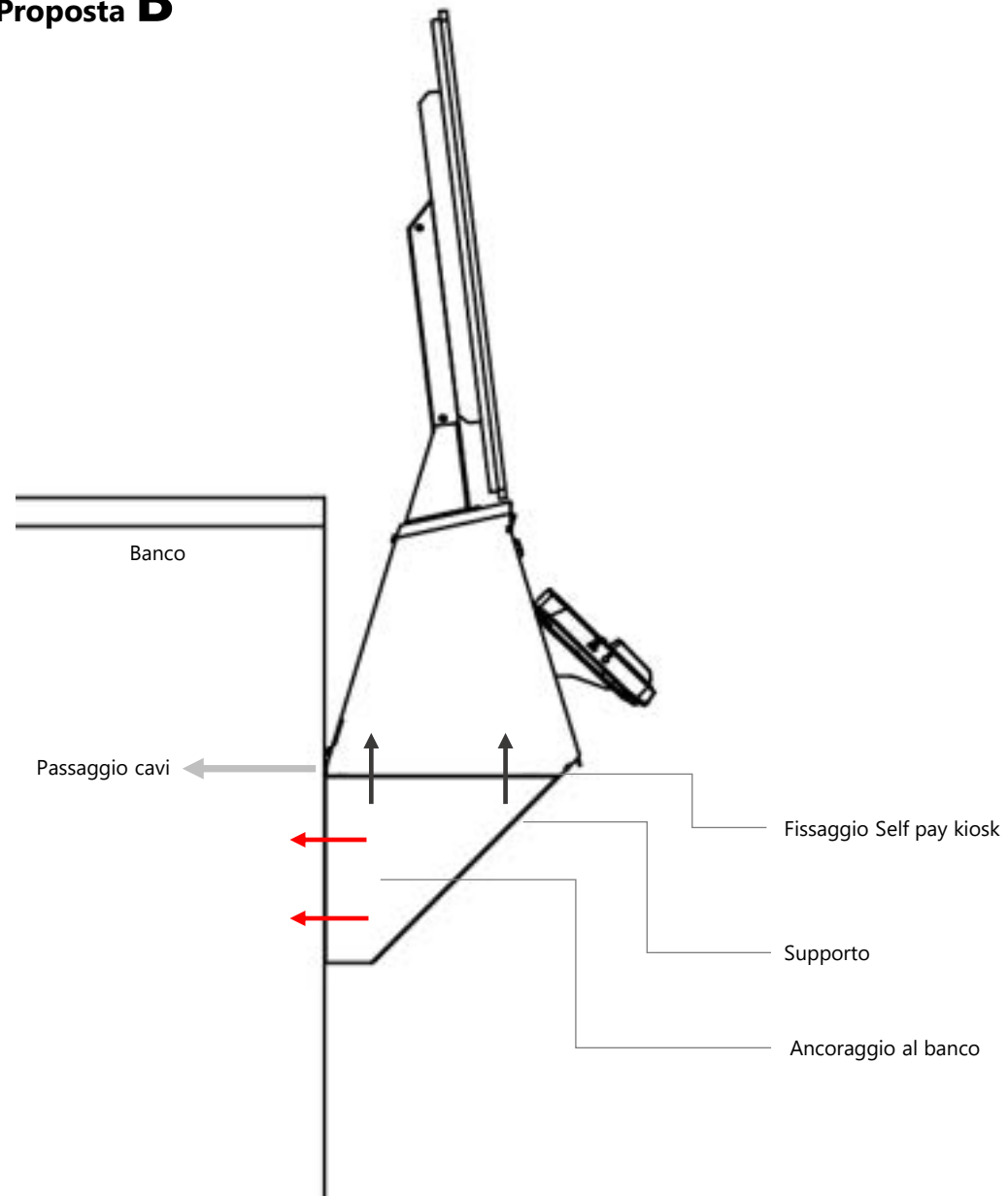

Esempio di installazione – misure espresse in cm (+ / -1cm)

Proposta **B**



Esempio di installazione – misure espresse in cm (+ / -1cm)

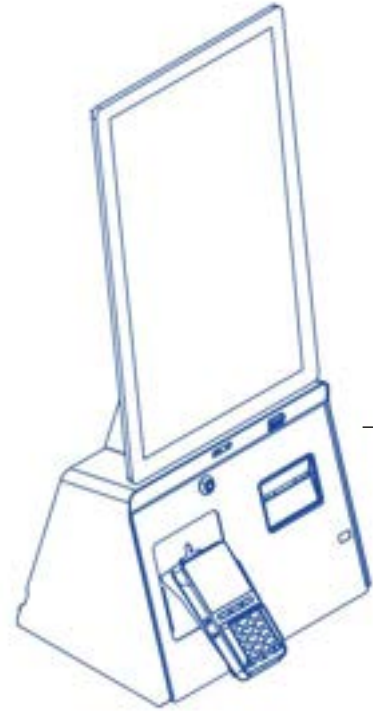

GRAZIE